

B 895 AERATION VALVE DATASHEET



Nominal size DN 10 - 80

Nominal size in inches 1/2 - 3

Nominal pressure PN in bar 10

Characteristics

- for safe ventilation of tanks
- reliable and low-maintenance
- ball / float made of PP

<https://www.stuebbe.com/en/products-and-systems/valves/>



Pictogram

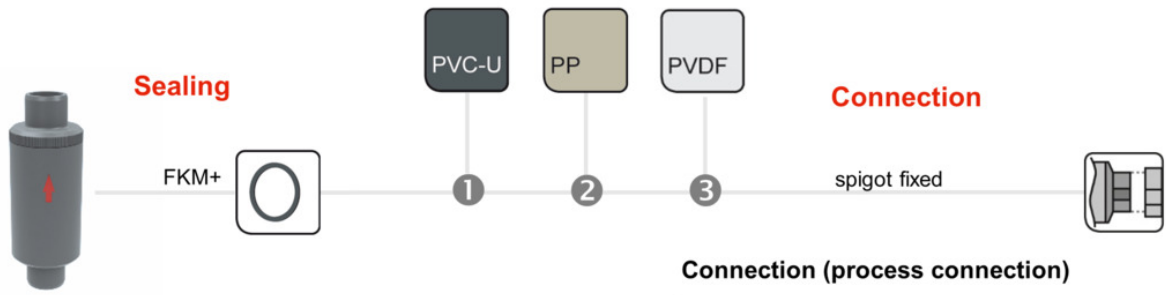

Connection (process connection)

- ① PVC-U spigot fixed
 - ② PP* spigot fixed
 - ③ PVDF* spigot fixed
- *only for socket welding

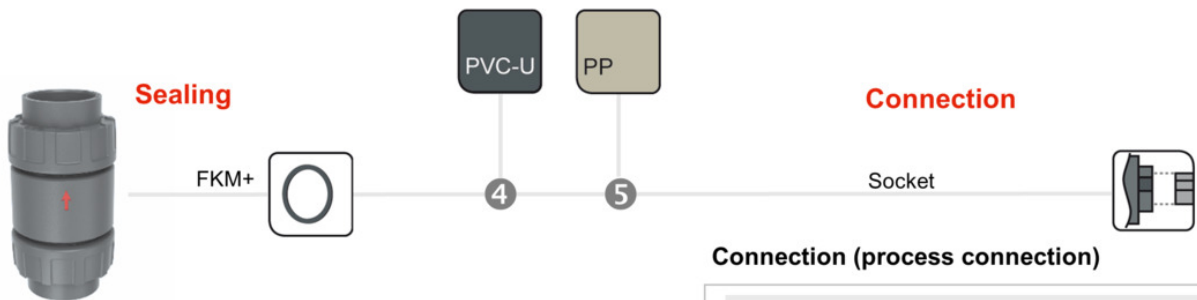

Connection (process connection)

- ④ PVC-U socket DIN
- ⑤ PP socket DIN

● Available

○ not available

Basic nominal diameters

DN 8	DN 10	DN 15	DN 20	DN 25	DN 32	DN 40	DN 50	DN 65	DN 80	DN 100	DN 125	DN 150	DN 200	DN 250	DN 300	DN 350	DN 400
------	-------	-------	-------	-------	-------	-------	-------	-------	-------	--------	--------	--------	--------	--------	--------	--------	--------

B 895 Aeration valve

Use	- Chemical plant manufacture - Water treatment
Application	- for ventilating process plants
Device connection	- see pictogram
Process pressure	- see pressure-/temperature diagram
STÜBBE resistance guide	- www.stuebbe.com/pdf_resistance/300051.pdf
Function	- Type B895 for aeration - Valve "Open" for negative pressure (draining), valve "Closed" by spring-loaded closing part - Opening pressure approx. 0.05 bar
Housing material (with medium contact)	- PVC-U - PP - PVDF
material thrust ring	- PVC-U - PP - PVDF
Material sealing element (in contact with medium)	- FKM+
Material ball	- PP
Nominal pressure PN in bar	- 10
Flow direction	- Always in the direction of the arrow
Mounting position	- Note "ABOVE" marking - vertical
Actuation	- medium-controlled
Operation Note	- Connect the aerator to a leakage line.
Testing	- according to DIN 3441, 3442 and 8063, DIN EN 12266
Application limits	- adhering media - Sticky or highly viscous liquids that prevent the float from positioning - not suitable for liquids with solid particles
CE Conformity	- Pressure equipment directive 2014/68/EU
Weblink Product	- https://www.stuebbe.com/en/products-and-systems/valves/

B 895 Aeration valve

flow rate Q

d	16	20	25	32	40	50	63	75	90
DN	10	15	20	25	32	40	50	65	80
DN*	3/8	1/2	3/4	1	1 1/4	1 1/2	2	2 1/2	3
Q(Nm ³ /H)	10	14	18	40	60	75	85	180	180

- Guide value: Flow velocity $V_{air} \sim 10-20$ m/s
- Flow rate related to air (Nm³/h)

B 895 Aeration valve

Pressure and temperature diagram PVC-U

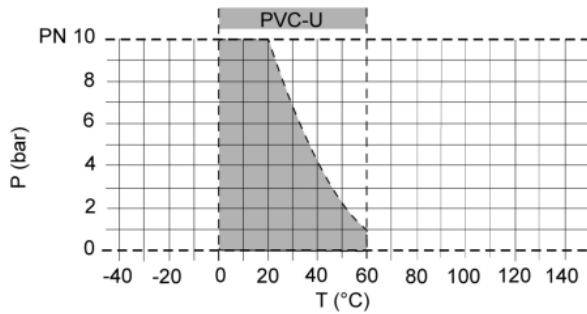

Pressure and temperature diagram PP

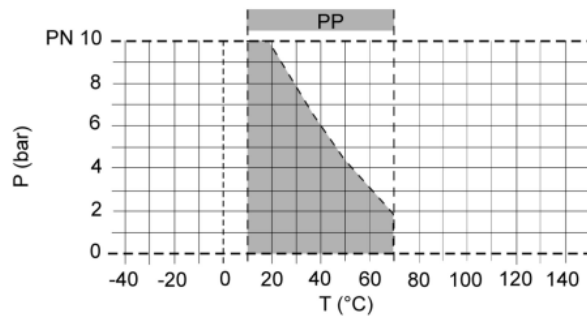

Pressure and temperature diagram PVDF

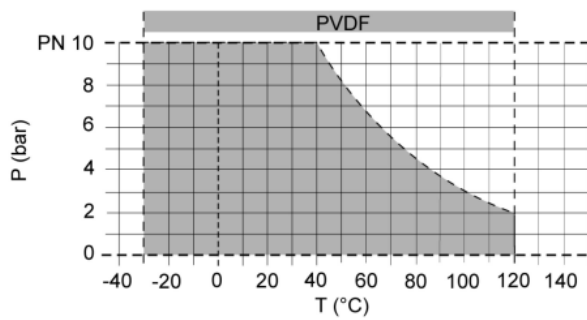

P = Operating pressure

T = Temperature

The pressure/temperature limits of the materials are valid for the stated nominal pressures and a service life of 25 years. These values are guide values for flow medium types which do not negatively impact the physical and chemical characteristics of the valve material. It may be necessary to take diminution factors into consideration.

B 895 Aeration valve

Dimensioned drawing

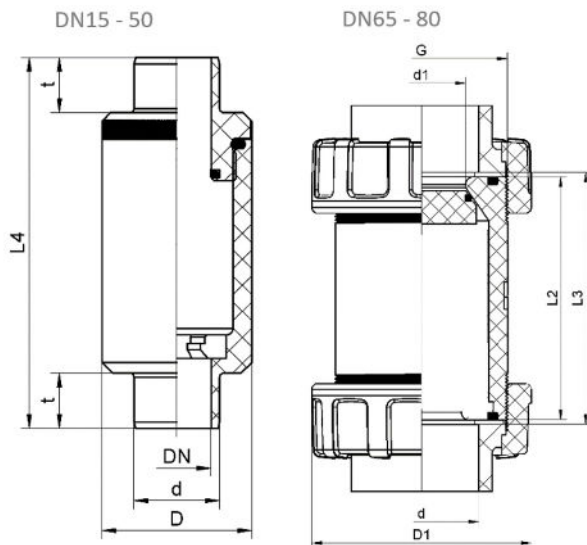

d	16	20	25	32	40	50	63	75	90
DN	10	15	20	25	32	40	50	65	80
DN*	3/8	1/2	3/4	1	1 1/4	1 1/2	2	2 1/2	3
d1	-	-	-	-	-	-	-	57,5	57,5
D	35	40	45	56	70	80	95	-	-
D1	-	-	-	-	-	-	-	134	134
G*	-	-	-	-	-	-	-	4	4
L2	-	-	-	-	-	-	-	160	160
L3	PVC-U	-	-	-	-	-	-	166	171,2
L3	PP	-	-	-	-	-	-	186	170
L4	114	124	144	154	174	194	224	-	-
t	14	16	19	22	26	31	38	-	-

all dimensions in mm / * in inch

B 895 Aeration valve

Bill of materials

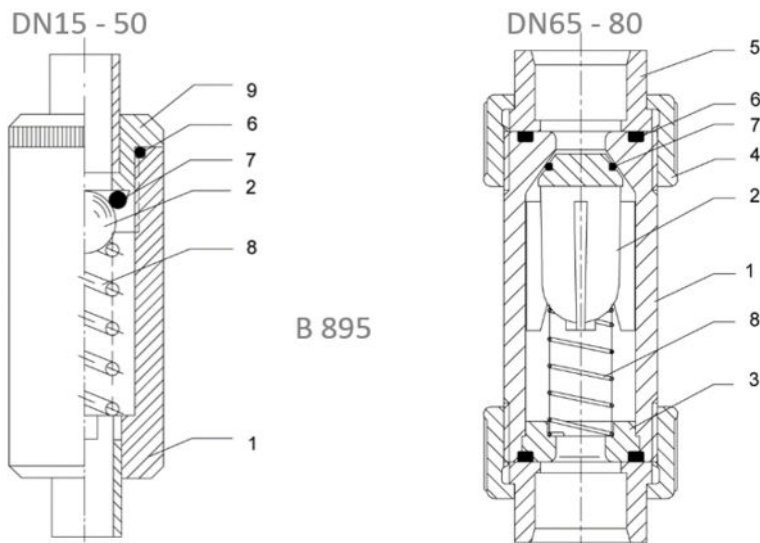

position	quantity	designation
1	1	housing
2	1	ball / float
3	1	Pressure disc
4	2	union nut
5	2	union end
6	2	O-ring
7	1	O-ring
8	1	pressure spring
9	1	Bonnet